



EUROPEAN CENTRAL BANK

EUROSYSTEM

Working Paper Series

Thore Kockerols, Christoffer Kok

Leaning against the wind:
macroprudential policy and the
financial cycle

No 2223 / January 2019

Abstract

Should monetary policy lean against financial stability risks? This has been a subject of fierce debate over the last decades. We contribute to the debate about “leaning against the wind” (LAW) along three lines. First, we evaluate the cost and benefits of LAW using the [Svensson \(2017\)](#) framework for the euro area and find that the costs outweigh the benefits. Second, we extend the framework to address a critique that Svensson does not consider the lower frequency financial cycle. Third, we use this extended framework to assess the costs and benefits of monetary and macroprudential policy. We find that macroprudential policy has net marginal benefits in addressing risks to financial stability in the euro area, whereas monetary policy has net marginal costs. This would suggest that an active use of macroprudential policies targeting financial stability risks would alleviate the burden on monetary policy to “lean against the wind”.

JEL: E58, G01

Keywords: leaning against the wind, macroprudential policy, financial cycle

Non-technical summary

The current accommodative stance of monetary policies around the globe is unprecedented in its scale and duration. The economic fundamentals justify the continued support but, as the buildup to the Global Financial Crisis (GFC) showed, keeping policy rates “too low for too long” can create financial stability risks. The question of how to address these risks has been debated since the 1990s.

We contribute to this debate by analysing the cost and benefits of “leaning against the wind” in the euro area. Furthermore, we take the financial cycle into account in our assessment and, last but not least, we bring macroprudential policy into the picture.

The debate on whether to use monetary policy to address risks to financial stability, or to “lean against the wind”, has been going on in policy and academic circles for at least two decades in two distinct stages. During the first stage, which lasted until the GFC, the prevailing view was that monetary policy should respond to fluctuations in asset prices only to the extent that they affect forecasts of inflation or the output gap (see e.g. [Bernanke and Gertler \(1999, 2001\)](#) and [Kohn \(2006, 2008\)](#)).

In the second stage, after the GFC, the focus turned towards credit-fuelled price bubbles and how to tackle such imbalances in the most effective manner. The severe consequences of credit-fuelled asset price bubbles called for the development of new policy instruments tailored to containing systemic risk, i.e. macroprudential policy.

Our contribution to this debate is based on the theoretical framework brought forward by [Svensson \(2017\)](#). Underlying this framework are assumptions about how LAW impacts the economy over time. Svensson argues that LAW not only has a cost in terms of a weaker economy if no crisis occurs but also substantial costs in terms of higher unemployment going into the crisis due to the policy.

The empirical analysis of Svensson concludes that the marginal costs of LAW far exceed the benefits. Svensson’s conclusions have been criticised by the Bank for International Settlements (BIS) and others for not properly accounting for systemic risks and the persistence of the financial cycle, which risks ignoring the long-lasting effects on the real economy that financial crises may have (see e.g. [Adrian and Liang \(2016\)](#), [BIS \(2016\)](#), [Filardo and Rungcharoenkitkul \(2016\)](#)),

Gourio et al. (2017)). Accounting for these elements, it is argued, would create a case for a more active use of monetary policy to lean against the financial cycle.

To shed further light on this question we have recalibrated Svensson's model for the euro area. Furthermore, we account for the critique of the BIS by modifying the Svensson framework to take into account the financial cycle. We do this by making the probability of a crisis start dependent on a financial cycle indicator.

Our main findings are that the recalibration comes to the same conclusion for the euro area as Svensson does for Sweden; namely, that LAW is associated with substantial net marginal costs (though slightly lower than the original Svensson result). Furthermore, when taking the financial cycle into account, we find that the effect of LAW still implies substantial marginal costs.

Turning to macroprudential policy, we focus on two measures. A permanent 1 percentage point (pp) increase in bank capital requirements and a permanent 1 pp tightening of loan-to-value (LTV) requirements. When modifying the model this way, we observe that these measures are more effective in reducing the probability and severity of financial crises (marginal benefits) and the marginal benefits of macroprudential policy outweigh the marginal costs. Overall, these findings would suggest a meaningful role for macroprudential policies to complement monetary policy and help alleviate the burden on monetary policy to lean against financial stability risks.

This notwithstanding, our findings are obviously driven by the specific, and arguably simplistic, features of the Svensson framework. Furthermore, it has to be kept in mind that macroprudential policy and monetary policy are to a large extent interdependent. These interdependencies imply the potential for a trade-off between the two policy functions as the transmission of macroprudential instruments is likely to affect the monetary policy transmission mechanism. These considerations do not contradict our findings but, they underline the need to ensure an appropriate institutional framework with effective coordination mechanisms across the different policy functions, with clear delineations of responsibility.

Introduction

The current accommodative stance of monetary policies around the globe is unprecedented in its scale and duration. The economic fundamentals justify the continued support but, as the buildup to the GFC showed, keeping policy rates “too low for too long” can create financial stability risks. The question of how to address these risks has been debated since the 1990s.

We contribute to this debate by analysing the cost and benefits of “leaning against the wind” in the euro area. Furthermore, we take the financial cycle into account in our assessment and, last but not least, we bring macroprudential policy into the picture.

The debate on whether to use monetary policy to address risks to financial stability, or to “lean against the wind”, has been going on in policy and academic circles for at least two decades in two distinct stages. The first stage can be traced back to the empirical findings of [Bernanke and Lown \(1991\)](#) and [Borio et al. \(1994\)](#), who documented a positive association between large fluctuations in equity and real estate prices and those in real economic activity. During this first stage, which lasted until the GFC, the prevailing view was that monetary policy should respond to fluctuations in asset prices only to the extent that they affect forecasts of inflation or the output gap.¹

This view was based on two main arguments:² first, the early identification and precise measurement of price bubbles in real time was difficult, if not outright impossible; second, even if such price misalignments were observed, it was argued, monetary policy would not be able to deal with them adequately. This was because the interest rate adjustments necessary to contain asset price bubbles could, as a side effect, trigger bubbles in other asset classes and instabilities in aggregate demand.

This view was not shared by everyone. Cecchetti and others called for a more active role for monetary policy in addressing financial stability risks.³ They argued that if expected inflation were to remain unaffected by an asset price bubble, which would be the case if the bubble did not last for too long, then reacting only to expected inflation would not prevent bubble-induced macroeconomic volatility.

¹See e.g. [Bernanke and Gertler \(1999, 2001\)](#) and [Kohn \(2006, 2008\)](#).

²See [Constâncio \(2018\)](#).

³See [Borio et al. \(2003\)](#), [Borio and Lowe \(2002\)](#) and [Cecchetti et al. \(2000, 2002\)](#).

Notably, in the pre-crisis stage, the debate neither centred on the role of excessive credit or risk-taking in fuelling asset price bubbles, nor did it consider the role of macroprudential policies.

This changed dramatically in the aftermath of the financial crisis, which ushered in the second stage of this debate. In this second stage, the focus first turned towards credit-fuelled price bubbles.⁴ These price misalignments are especially harmful because they generate feedback loops in financial markets that can considerably exacerbate systemic risk and financial instability.⁵

Second, the debate has focused on how to tackle such imbalances in the most effective manner. The severe consequences of credit-fuelled asset price bubbles called for the development of new policy instruments tailored to containing systemic risk, i.e. macroprudential policy. A discussion has also emerged on whether monetary policy should coordinate with macroprudential policy to jointly safeguard financial stability. This coordination would be predicated on the strong mutual dependencies between the two policy functions and reflect uncertainty about whether macroprudential policy can fulfil all its objectives.

Two opposing viewpoints have been put forward, calling for either (i) two separate policy functions, which would keep the pre-crisis, price stability-oriented, monetary policy frameworks largely unchanged,⁶ or (ii) fully merging monetary policy and macroprudential policy.⁷

According to Smets (2014), the need to incorporate, to some extent, financial stability concerns into monetary policy objectives hinges on: (i) the effectiveness of macroprudential policies (e.g. the ability to manage the financial cycle); (ii) the extent to which monetary policy (including conventional and unconventional measures) can be a source of financial instability, for example by incentivising bank risk-taking; and (iii) the extent to which monetary policy can remain independent from financial stability concerns, especially in crisis times.⁸

⁴See Brunnermeier et al. (2017), Brunnermeier and Schnabel (2016) and Jordà et al. (2015a,b).

⁵Systemic risk can be defined as “the risk that the provision of necessary financial products and services by the financial system will be impaired to a point where economic growth and welfare may be materially affected.” It can arise from “(i) an endogenous build-up of financial imbalances, possibly associated with a booming financial cycle; (ii) a large aggregate shock hitting the economy or the financial system; or (iii) from contagion effects across markets, intermediaries or infrastructures”. For definitions see the European Central Bank (ECB) financial stability website at <http://www.ecb.europa.eu/ecb/tasks/stability/html/index.en.html>.

⁶See e.g. Bean et al. (2010).

⁷See e.g. Brunnermeier and Sannikov (2013).

⁸To the extent that an extended monetary policy mandate including financial stability concerns, as a complement to macroprudential policies, can help prevent the build-up of excessive debt overhangs in pre-crisis periods, it could alleviate the need for monetary policy to engage in post-crisis resolution policies.

The dominant view in the post-crisis stage still prescribes that monetary policy should not respond to financial stability concerns. The reason is now, however, different: the new macroprudential policies are deemed the most effective tool for ensuring financial stability, because they can directly restrain excessive leverage or risk-taking. Reinforcing this view, [Korinek and Simsek \(2016\)](#) have recently shown that an increase in interest rates can in fact lead to a higher level of household indebtedness and financial instability, because higher interest rates also increase the debt service burden and lower the income of the borrowers, who then borrow more to smooth consumption.

Focusing on monetary policy and equipped with a model-based approach, [Gerdrup et al. \(2017\)](#) and [Filardo and Rungcharoenkitkul \(2016\)](#), find evidence in support of LAW. [Gerdrup et al. \(2017\)](#) base their analysis on a standard New-Keynesian framework with regime-switching and implement an optimal rule that generates net benefits, mainly by reducing output volatility.

Contributing to this debate, we highlight three points: (i) we evaluate the costs and benefits of LAW in the euro area; (ii) we extend the model to take into account the financial cycle; and (iii) we evaluate macroprudential and monetary policy using the extended framework with regards to the cost and benefits of addressing financial stability risks.

The analysis is based on the theoretical framework brought forward by [Svensson \(2017\)](#). The dynamic stochastic general equilibrium (DSGE) model underlying the cost benefit framework includes an inflation-targeting central bank. The cost of LAW is measured by the increase in unemployment following a monetary policy tightening, and benefits are related to a lower probability and severity of financial crises. The empirical results are based on a monetary policy shock in a calibrated DSGE model for Sweden.

Svensson argues that LAW not only has a cost in terms of a weaker economy if no crisis occurs but also substantial costs in terms of higher unemployment going into the crisis due to the policy.

The empirical analysis of Svensson concludes that the marginal costs of LAW far exceed the benefits. In other words, the cost of higher unemployment as a result of the monetary policy tightening far outweighs the benefits of the reduced probability and severity of financial crises.

Svensson's conclusions have been criticised by the BIS and others for not properly accounting for systemic risk and the persistence of the financial cycle, which risks ignoring the long-lasting

effects on the real economy that financial crises may have.⁹ Accounting for these elements, it is argued, would create a case for a more active use of monetary policy to lean against the financial cycle.

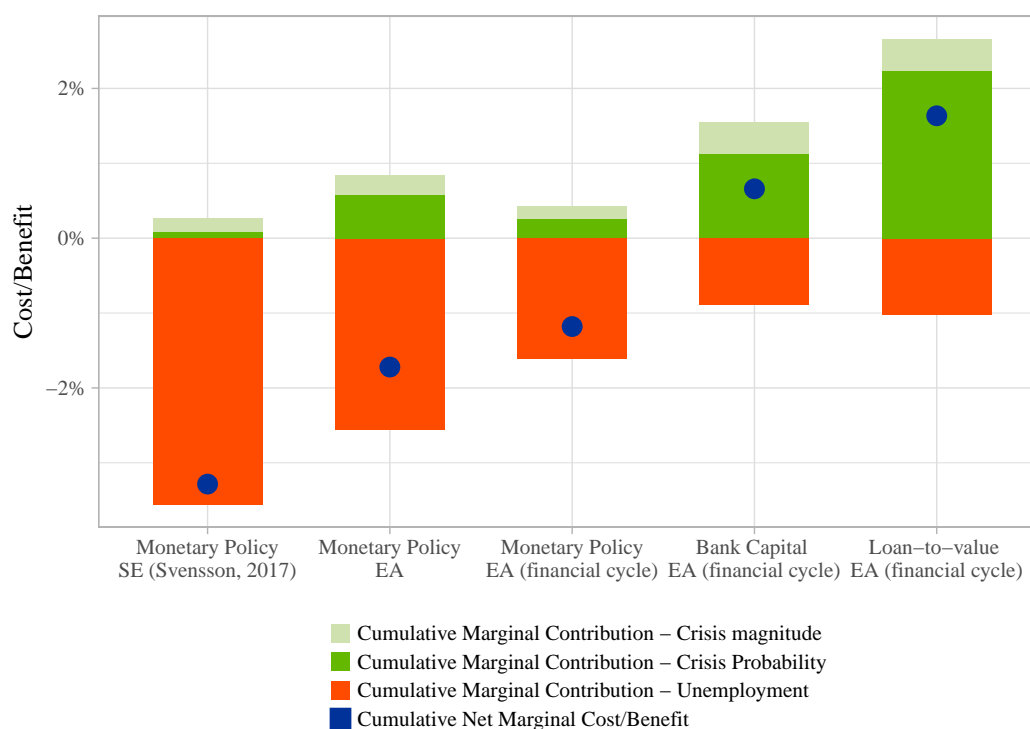

Figure 1: Comparing the cost and benefits of monetary and macroprudential policy “leaning against the wind”

To shed further light on this question we have recalibrated Svensson’s model for the euro area.¹⁰ Furthermore, we account for the critique of the BIS by modifying the Svensson framework to take into account the financial cycle. We do this by making the probability of a crisis start dependent on a financial cycle indicator. Figure 1 summarises our main findings. The figure shows that the recalibration comes to the same conclusion for the euro area as Svensson does for Sweden; namely, that LAW is associated with substantial net marginal costs (though slightly lower than the original Svensson result; see second bar from the left). Furthermore, when taking into account the financial cycle, we find that the effect of LAW still implies substantial marginal costs (see third bar). The different outcomes between our analysis and the approach taken by Gerdrup et al. (2017) stem from the nature of the policy intervention and the sensitivities of real and financial variables to policy interventions. First, in the latter a policy intervention is optimal

⁹See e.g. Adrian and Liang (2016), BIS (2016), Filardo and Rungcharoenkitkul (2016), Gourio et al. (2017).

¹⁰To calibrate the Svensson model for the euro area, the DSGE model of Darracq Pariès et al. (2011) was used.

through the cycle compared to a one-time discretionary intervention in Svensson’s framework. Thereby, “collateral damage” to the economy is minimised. Second, financial variables react very differently (stronger reduction in debt growth in the latter analysis) and imply a higher benefit of reducing crisis probability in the analysis by [Gerdrup et al. \(2017\)](#).

Turning to macroprudential policy, we focus on two measures. A permanent 1 pp increase in bank capital requirements and a permanent 1 pp tightening in LTV requirements. When modifying the model this way, we observe (fourth and fifth bar) that these measures are more effective in reducing the probability and severity of financial crises (marginal benefits) and that the negative impact on unemployment is lower (marginal costs), than a monetary policy that tries to address financial stability risks. Overall, the marginal benefits of macroprudential policy outweigh the marginal costs. Note that we consider the interaction with the financial cycle for the assessment of macroprudential policy. Overall, these findings would suggest a meaningful role for macroprudential policies in complementing monetary policy and helping alleviate the burden on monetary policy to lean against financial stability risks.¹¹

The paper is structured as follows: Section 1 describes the Svensson framework underlying our analysis throughout. Section 2 takes Svensson’s analysis for monetary policy to the euro area. Section 3 describes our extension of the Svensson model to consider the financial cycle and evaluates monetary policy in this extended framework. Section 4 analyses macroprudential policy in the extended framework. Section 5 carries out robustness checks and Section 6 discusses the results. Finally, Section 7 concludes.

1 Svensson framework

We base our calculations on the framework defined by [Svensson \(2017\)](#). Before discussing the evaluation of the different policy options, we will explain in the following the underlying framework and the parameters used.

The Svensson framework is based on a quadratic loss function of unemployment. Assuming a

¹¹In the context of the euro area, the relative effectiveness of macroprudential policy to tackle the build-up of financial stability risks may be even more pronounced owing to the fact that, in a monetary union, a single monetary policy is not well-suited to deal with financial imbalances building up at national level. Such imbalances are indeed better tackled with targeted national macroprudential measures ([Darracq Pariès et al., 2019](#)).

monetary policy that stabilises both the inflation rate around an inflation target and the unemployment rate around its long-run sustainable rate, we define, u_t^* , as the optimal unemployment rate under flexible inflation targeting when the possibility of a financial crisis is disregarded. The loss from the unemployment rate deviating from the benchmark unemployment rate, u_t^* , can be represented by the quadratic (indirect) loss function:

$$L_t = (\tilde{u}_t)^2,$$

with, $\tilde{u}_t = u_t - u_t^*$, being the unemployment deviation.¹²

For the purpose of evaluating the costs and benefits of different policy options we consider two states of the economy after period 1. With a probability p_t the economy is in a crisis state and the crisis unemployment deviation, \tilde{u}_t^c , is conditional on being in a crisis state. For the non-crisis state, which occurs with probability $1 - p_t$, the unemployment deviation is denoted by \tilde{u}_t^n .

The expected quarter-t loss conditional on information available in quarter 1 can be written as:

$$\mathbb{E}_1 L_t = \mathbb{E}_1 (\tilde{u}_t)^2 = (1 - p_t) \mathbb{E}_1 (\tilde{u}_t^n)^2 + p_t \mathbb{E}_1 (\tilde{u}_t^c)^2.$$

The crisis unemployment deviation, \tilde{u}_t^c , is composed of two components. A crisis increase in the unemployment rate net of any policy reaction, Δu , and the non-crisis unemployment deviation, \tilde{u}_t^n . Therefore, we can rewrite the expected quarter-t loss as:

$$\begin{aligned} \mathbb{E}_1 L_t &= (1 - p_t) \mathbb{E}_1 (\tilde{u}_t^n)^2 + p_t \mathbb{E}_1 (\Delta u_t + \tilde{u}_t^n)^2, \\ &= \mathbb{E}_1 (\tilde{u}_t^n)^2 + p_t \left(\mathbb{E}_1 (\Delta u_t + \tilde{u}_t^n)^2 - \mathbb{E}_1 (\tilde{u}_t^n)^2 \right), \\ &= \mathbb{E}_1 (\tilde{u}_t^n)^2 + p_t \underbrace{\left(\mathbb{E}_1 (\Delta u_t)^2 + 2 \mathbb{E}_1 (\tilde{u}_t^n \Delta u_t) \right)}_{\text{cost of a crisis}}. \end{aligned}$$

The second term in the last two expressions deserves further explanation. This term describes the cost of a crisis as being the crisis deviation less the non-crisis deviation.

Any policy will have an impact on the quarter-t loss and we define the net marginal cost, NMC_t , as the derivative of the quarter-t loss function with respect to the policy measure, \mathbf{p}_1^i , implemented

¹²See Appendix A of [Svensson \(2017\)](#) for further details on the quadratic loss function.

to address risks to financial stability:

$$\text{NMC}_t = \frac{d\mathbb{E}_1 L_t}{d\mathbf{p}_1^i}.$$

Taking the partial derivatives for each component of the rewritten quarter-t loss function yields:

$$\text{MC}_t = 2(\mathbb{E}_1 \tilde{u}_t^n + p_t \mathbb{E}_1 \Delta u_t) \frac{d\mathbb{E}_1 u_t^n}{d\mathbf{p}_1^i}, \quad (1)$$

$$\text{MB}_t^p = -\left(\mathbb{E}_1 (\Delta u_t)^2 + 2\mathbb{E}_1 (\tilde{u}_t^n \Delta u_t)\right) \frac{dp_t}{d\mathbf{p}_1^i}, \quad (2)$$

$$\text{MB}_t^{\Delta u} = -2p_t \mathbb{E}_1 (\tilde{u}_t^n + \Delta u_t) \frac{d\mathbb{E}_1 \Delta u_t}{d\mathbf{p}_1^i}, \quad (3)$$

$$\text{NMC}_t = \text{MC}_t - (\text{MB}_t^p + \text{MB}_t^{\Delta u}), \quad (4)$$

with MC_t being the marginal cost related to the change in the unemployment rate, MB_t^p being the benefits from a lower probability of a crisis, and $\text{MB}_t^{\Delta u}$ being the benefit of a reduced severity of a crisis.

In order to assess whether a policy is favourable, we look at the cumulated net marginal cost:¹³

$$\text{NMC} = \sum_{t=1}^{\infty} \text{NMC}_t = \sum_{t=1}^{\infty} \text{MC}_t - \left(\sum_{t=1}^{\infty} \text{MB}_t^{\Delta u} + \sum_{t=1}^{\infty} \text{MB}_t^p \right).$$

Here, we will look at the cumulated net marginal cost after 40 quarters.

In order to evaluate policies in our framework, we need to define what values the static and dynamic components of the framework will take. Since we are taking partial derivatives, we need to define the constant values of the probability of a crisis, the non-crisis unemployment deviation, and the crisis increase in the unemployment rate.

The probability of being in a crisis is determined, assuming a Markov process,¹⁴ by the probability of a crisis start and the crisis duration. We stick to the benchmark calibration of [Svensson \(2017\)](#) and assume a crisis duration of eight quarters and a quarterly probability of a crisis start of

¹³We do not consider discounting, in line with [Svensson \(2017\)](#).

¹⁴See Appendix C in [Svensson \(2017\)](#) for further details on the Markov process.

$q_t = 0.8\%$.¹⁵ Using a simple linear approximation¹⁶ these values imply a steady state probability of being in a crisis of around $p_t = 6\%$.

Underlying the quarterly probability of a crisis start is a logistic function that links the policy impact via debt growth to the probability of a crisis.¹⁷ The constant crisis probability is therefore dependent on the steady state growth of debt. Again we rely on the benchmark calibration and assume a 5% per annum growth in debt. Note that this assumption will change when considering the financial cycle, as will be explained in Section 3.

As for the crisis increase in unemployment, Δu , we take the benchmark value of a 5 pp increase. Svensson refers to estimates of the crisis unemployment increase from IMF (2015) and Sveriges Riksbank (2013). A larger crisis increase in unemployment would lead to higher net marginal benefits because of the quadratic term in the marginal benefits of a lower probability of a crisis start, see equation (2), and the otherwise linear influence of the crisis increase on the costs, see equation (1).

With regard to the benefits of a less severe crisis, we rely on the conservative estimates found in Sveriges Riksbank (2014). These estimates, which Svensson uses in his framework, imply that the marginal benefit is equal to 0.02 times the policy effect on the household debt-to-income ratio.

All three parts rely on calibrated parameters, where we stick to the original benchmark calibration by Svensson, and policy responses. We use the benchmark calibration in order to ensure comparability and because this calibration is very conservative and tilted in favour of LAW. The relevant impulse responses going into the Svensson framework are: unemployment [pp] for marginal cost, real household debt growth [%] for marginal benefit of a lower probability of a crisis and the debt-to-income ratio [pp] for the severity of a crisis.

¹⁵The eight quarters crisis duration Svensson assumes are to be seen in combination with the 5 pp unemployment increase. Taken together, 10 pp-years of unemployment deviation determine the severity of the crisis in the model.

¹⁶The linear approximation is the sum of the quarterly probabilities of a crisis start over eight quarters: $p_t \approx \sum_{i=0}^{n-1} q_{t-i}$.

¹⁷The function is taken from the estimates found in Schularick and Taylor (2012).

2 Monetary policy “leaning against the wind” in the euro area

First, we want to contrast the results of Svensson with those of the euro area. After all, Sweden is a small open economy and the euro area is not. Therefore, monetary policy will have different effects on the macroeconomy. The results for monetary policy “leaning against the wind” are achieved by assuming the policy rate to be 1 pp above the flexible inflation targeting implied equilibrium rate for four quarters and to move endogenously thereafter.¹⁸ This policy experiment in [Svensson \(2017\)](#) is conducted using the RAMSES DSGE model for Sweden.¹⁹ In order to calibrate the Svensson framework for the euro area, we employ the estimated closed economy DSGE model of [Darracq Pariès et al. \(2011\)](#).²⁰ The impulse response functions (IRFs) for real gross domestic product (GDP) and real household and firm debt are then used to calculate the unemployment deviation (proxied by the GDP deviation times the Okun coefficient, with a value of 2), household debt growth and the debt-to-income ratio (total debt/GDP). These three series are used as inputs in the cost-benefit framework by [Svensson \(2017\)](#). The unemployment deviation drives the marginal costs, debt growth drives the probability of crisis and the debt-to-income ratio drives the severity of crisis.

Svensson’s framework allows us to look at the cost over time. In order to establish whether a policy has net benefits or net costs, we look at the cumulative costs and benefits over 40 quarters.

For monetary policy we can see that the marginal costs are driving the results (see [Figure 3](#)). Monetary policy has a relatively strong impact on the real economy and the benefits are not sufficient to outweigh these high costs over time. An interest rate increase does lower debt and debt-to-income in the long term but not enough to tip the balance between costs and benefits over the horizon of 40 quarters. In the short run an interest rate hike leads to an increase in debt levels (see [Figure 2](#)). This result is confirmed by [Korinek and Simsek \(2016\)](#) and [Gelain et al. \(2018\)](#) and exacerbates the negative effects of monetary policy in the short run. Only in the medium term does the debt-to-income ratio decrease. The result of Svensson for “leaning against the wind” can be confirmed for the euro area, whereas the cumulated net marginal costs are slightly lower but still strongly negative.

¹⁸We achieve this by extracting the monetary policy shocks from a conditional forecast on the policy rate being fixed for four quarters.

¹⁹See [Adolfson et al. \(2013\)](#).

²⁰See [Appendix A](#) for an overview of the model.

3 Financial Cycle

A critique of the Svensson framework is that “leaning against the wind” is implemented as an interest rate deviation of 1 pp above flexible inflation targeting for four quarters and not as a through the financial cycle optimisation, as presented in [Filardo and Rungcharoenkitkul \(2016\)](#). Furthermore, the authors argue that Svensson’s framework is unable to capture the effect of the financial cycle on the costs and benefits of LAW. [BIS \(2016\)](#) underlines that the financial cycle has a much lower frequency and that risks build up gradually. These features are not captured in Svensson’s framework because of the shorter time horizons used.

We take this critique into account by employing the Systemic Risk Indicator (SRI) developed at the ECB.²¹ It is designed as an early warning indicator of cyclical systemic risk and consists of a weighted average of the following normed variables:

- 2-year change in bank credit-to-GDP ratio
- 2-year growth rate of real total credit
- 3-year change in residential real estate price-to-income ratio
- 2-year change in the debt-service ratio
- 3-year growth rate of real equity prices
- Current account-to-GDP ratio

In order to incorporate the lower frequency of the financial cycle into the Svensson framework, we have to establish the link between the probability of a crisis start and the financial cycle, more specifically the SRI in our case.²² In the original framework, Svensson relies on estimations done by [Schularick and Taylor \(2012\)](#). These calculations establish a link between credit growth and periods of financial crisis as defined by their database.²³ The SRI, on the other hand, was developed using the financial crisis database by [Lo Duca et al. \(2017\)](#). This database focuses on Europe and provides crisis start and end dates by month.

²¹See [European Central Bank \(2018\)](#) for details on the SRI.

²²See [Schüler et al. \(2015\)](#) or [Rünstler and Vlekke \(2018\)](#) for an analysis of the financial cycle in the euro area.

²³The financial crisis database underlying their calculations, which covers 17 developed countries from 1870 onwards on a yearly basis, can be found here: <http://www.macrohstory.net/data>.

Before regressing the SRI on the crisis start dates, we have to construct the SRI from the IRFs of the DSGE model. Since the [Darracq Pariès et al. \(2011\)](#) model does not include an external sector or equity markets, we cannot include the three year growth rate of real equity prices and current account-to-GDP ratio in the calculation of the SRI. Therefore, we take a reduced version of the SRI based on the other four variables: the two year change in bank credit-to-GDP ratio, two year growth rate of real total credit, the three year change in residential real estate price-to-income ratio, and the two year change in the debt-service ratio. [Table 1](#) shows the weights used in constructing the SRI. These are chosen to optimise the early warning properties of the SRI for systemic financial crisis, using a constrained least squares regression. The variables used in the regression are normalised with their mean and standard deviation across time and geographies.

Having constructed the four-variable SRI, we run the following regressions:

$$Pr(p_{i,t}) = b_{0,i} + b_1(L)SRI_{i,t} + b_2X_i + \varepsilon_{i,t},$$

with $b_1(L)$ being the lag polynomial of zero up to twenty quarters, and X_i being country fixed effects. The left-hand side variable is the probability of a crisis start in the respective quarter.

Given that the lags of the SRI are highly autocorrelated and therefore multicollinear, we resort to regularisation techniques for variable selection. Using an elastic net regression, we identify the relevant lags and use the maximum likelihood estimates.²⁴ [Table 2](#) shows the result of the maximum likelihood regression for the selected variables. Using cross-validation for selecting the hyperparameters of the elastic net, the regularisation finds lags 7 to 10 to be relevant.

From left to right we add lags in time steps of four quarters, starting with the contemporaneous effect of the SRI on the probability of a crisis start. [Column \(4\)](#) shows the regression on the variables selected by the elastic net. The Area under Receiver Operating Characteristic (AUROC) for the specification without time lags is relatively low at 0.64. When adding the four-quarter lag (see [column \(2\)](#)) we see that the AUROC increases up to a value of 0.86, and adding the eight-quarter lag leads to a slightly lower AUROC of 0.84. In comparison, the full specification in [Schularick and Taylor \(2012\)](#) including lags up to five years has a slightly higher AUROC, but features country fixed effects. The elastic net excluded country fixed effects in our case. The

²⁴See [Zou and Hastie \(2005\)](#) for further details on the elastic net regularisation technique.

variables selected by the elastic net yield an AUROC of 0.84 and have the lowest log likelihood (see column (4)). Their Akaike information criterion (AIC) value is at about the same level as for the specification in column (3).

The functional form implies a quarterly probability of a crisis start of: 0.5% versus the 0.8% used in Svensson's calculations. The difference is due the different samples of the financial crisis databases used. [Schularick and Taylor \(2012\)](#) goes back to 1870 and covers 17 developed countries, whereas [Lo Duca et al. \(2017\)](#) covers 22 European countries that experienced a financial crisis since 1970.

Coming back to the critique by the BIS, which was about monetary policy and its effect on the financial cycle, we will now discuss the results for “leaning against the wind” with our augmented version of the Svensson framework considering the financial cycle.

We can see in [Figure 2](#) that monetary policy has a strong impact on the SRI. It rises sharply in the beginning only to drop significantly to a low point after 2.5 years. The marginal benefits from a lower probability of a crisis are actually costs in the medium term because the SRI implies an increase in the probability of a crisis. Only towards the end of the 40 period horizon does the cumulated benefit of a lower probability of a crisis contribute to lowering the net cost. On top of this, there are the marginal cost in the form of the unemployment deviation and the marginal benefits of a less severe crisis, which are small compared to the marginal costs (see [Figure 4](#)).

To conclude, when considering the financial cycle, it is equally inadvisable according to the extended framework to use monetary policy to address financial stability risks. Nonetheless, the critique by the BIS is warranted in light of the results. The net marginal costs are lower when considering the financial cycle, but the benefits of a lower probability of a crisis start are not enough to tip the balance.

4 Macprudential policy

Staying within the Svensson framework augmented to take account of the financial cycle, we will now turn our attention to macroprudential policy. To what extent is macroprudential policy the right tool to address financial stability risks? Macroprudential policy interventions are

represented here as an increase in banking sector capital requirements by 1 pp or a tightening in the LTV requirements by 1 pp.

We argue for one more additional change to the original framework to account for the financial cycle. We consider longer time horizons for which policy is activated to reflect the persistence and length of the financial cycle, 7.8 years on average in the euro area (Schüler et al., 2015). Furthermore, longer time horizons for the activation of macroprudential policy are more realistic.

Slight changes to the original DSGE model need to be incorporated for these simulations. For bank capital requirements, we assume an exogenous stationary AR(1) shock to the 11% bank capital requirements. With regard to the LTV requirements, we define LTV ratios for entrepreneurs and borrowing households as determined by a common LTV shock scaled to have the same absolute impact on both ratios. One has to bear in mind that a tightening of LTV requirements in the model does not fully represent how this tool is used in reality. In the model, we reduce the average LTV requirements, whereas in reality this tool is mostly used as a cap on LTV ratios. Therefore, a 1 pp reduction in average LTV corresponds to a lower cap of LTV ratios, depending on the distribution of LTV ratios.

Starting with bank capital requirements, we assume a 1 pp increase over the length of the financial cycle (7.8 years or 31 quarters). Figure 5 shows that the changes to debt levels are more pronounced and persistent than for LAW for four quarters. At the same time, the SRI is reduced significantly, reaching a low point 2.5 years after implementation of the policy. Unemployment increases slightly and goes down only towards the end of the 40 quarters considered here. These IRFs translate into considerable marginal costs (see Figure 6). Nonetheless, the movements in the SRI are translated into marginal benefits outweighing the cost and tipping the balance in favour of using bank capital requirements to address financial stability risks. The benefits of a less severe crisis are not to be neglected either. The debt-to-income ratio decreases significantly and translates into a significantly less severe crisis unemployment deviation.

Coming to LTV requirements, we find that decreasing the LTV requirements of both firms and households by 1 pp leads to a much stronger reaction of the macroeconomy than changing the bank capital requirements (see Figure 5). Unemployment rises sharply and recedes to an elevated level. At the same time, debt and the debt-to-income ratio decrease more, after an initial increase. Finally, the SRI reaches the bottom after 2.5 years but at a level more than twice as low as

for the bank capital requirements. These IRFs imply a much higher marginal cost (see Figure 7). Surprisingly, the benefits of a less severe crisis alone outweigh the marginal costs after 40 quarters. The probability of a crisis ultimately adds to the marginal benefits, although only slightly. In net cumulative terms, tightening the LTV requirements by 1 pp for 31 quarters is beneficial.

5 Robustness

5.1 Permanent policy changes

It can be argued that in practice changes in macroprudential policy occur only very prudently. The contribution of the Svensson framework is that we can assess the cost and benefits of the *implementation* of a policy in contrast to a static level assessment. The DSGE model by [Darracq Pariès et al. \(2011\)](#) is calibrated to reflect bank capital and LTV ratios in the euro area. Therefore, the investigation of whether a permanent change in bank capital or LTV requirements is advisable in order to tackle financial stability risks has merit.

Our results show that a permanent increase in bank capital requirements of 1 pp has net marginal benefits after 40 quarters (see Figure 9). The results are driven by the permanent decrease in debt levels and a strong reduction in the SRI (see Figure 8). The benefits outweigh the cost already after 23 quarters, and it is therefore advisable to use bank capital requirements in order to address financial stability concerns.

The cost benefit assessment of LTV requirements reaches the same conclusion using the Svensson framework. A permanent decrease in the LTV requirements for entrepreneurs and borrowing households has net cumulated marginal benefits, outweighing marginal costs already after 18 quarters and have cumulative net benefits after 40 quarters (see Figure 10).

5.2 Short-run implementation of macroprudential policy

Having laid out in Section 3 that a policy implementation over a longer horizon corresponds more naturally to the idea of the financial cycle, it is nonetheless worth exploring the results for

shorter time spans of policy implementations.

As for monetary policy, we consider in the following a policy activation for 4 quarters. Starting with bank capital requirements, we find that a temporary increase in regulatory bank capital by 1 pp for four quarters has only marginal effects on the economy compared to LAW (see Figure 11). Debt levels do go down and unemployment is slightly higher. The higher unemployment drives the marginal costs, which in this case dominate the cost-benefit analysis after 40 quarters (see Figure 12). The erratic movement of the SRI in response to the policy leads to a cumulated cost of a higher probability of a crisis after around 20 quarters. In the end, the probability of a crisis has a cumulated benefit. The reduced debt levels only lead to comparatively very low cumulated marginal benefits due to a less severe crisis. In contrast to a longer time horizon of activation, there are net marginal costs for the short term use of bank capital requirements to address financial stability risks.

A four-quarter policy of a 1 pp tighter LTV requirement has a more persistent although weak effect on unemployment, debt levels and the SRI (see Figure 11). The benefits of a lower probability of a crisis start drive the results. In the short term, the cumulative costs outweigh the benefits, but after eight quarters the implementation has cumulated net marginal benefits (see Figure 13). Therefore, even a short term implementation of LTV requirements has net benefits in the long run although the benefits are much larger for longer activation time spans.

We conclude that both macroprudential tools, if changed, should stay at their new respective levels in order to generate substantial benefits for the economy.

6 Discussion

The finding that macroprudential policies are better suited to addressing financial stability risks than monetary policy is supported by a range of studies.²⁵ This notwithstanding, our findings are obviously driven by the specific, and arguably simplistic, features of the Svensson framework. While we accommodate some of the criticism of the original Svensson approach (by studies such as [Adrian and Liang \(2016\)](#), [Filardo and Rungcharoenkitkul \(2016\)](#) and [Gourio et al. \(2017\)](#)) by

²⁵See e.g. [Angelini et al. \(2012a\)](#), [Angeloni and Faia \(2013\)](#), [Beau et al. \(2012\)](#), [Christensen et al. \(2011\)](#), [Darracq Pariès et al. \(2011\)](#) and [Lambertini et al. \(2013\)](#).

taking into account the longevity of financial cycles as compared to business cycle fluctuations, we acknowledge that further work is warranted to substantiate and improve the robustness of the finding that macroprudential policy is the preferred tool over monetary policy to lean against the build up of financial cycles.

As Jeremy Stein has observed, there may be situations where LAW is warranted as it “gets into all the cracks” of the financial system.²⁶ In other words, in some circumstances, either due to the nature of financial stability risks or due to the potentially limited effectiveness of the targeted macroprudential tools, some LAW may improve welfare.²⁷

Furthermore, it has to be kept in mind that macroprudential policy and monetary policy are to a large extent interdependent. These interdependencies imply the potential for a trade-off between the two policy functions as the transmission of macroprudential instruments are likely to affect the monetary policy transmission mechanism. It is to be expected that a monetary policy change will often impact the macroprudential policy stance (e.g. through its effect on bank profitability and risk-taking behaviour in the economy). Vice versa, changes in macroprudential policy, such as an adjustment of capital buffer requirements or changes to borrower-based measures (e.g. LTV ratios), are likely to affect general economic activity (via credit provisioning, asset prices and the impact of economic activity on overall financing conditions) and thus may influence the monetary policy stance. As highlighted by inter alia [Carboni et al. \(2013\)](#), price stability and financial stability are complementary and will often be mutually reinforcing.²⁸ In general, it is thus likely that in many instances there will be strategic complementarities between the two policy functions and that actions in one area will be supportive of the other policy area. However, there can also be potential for conflict between monetary and macroprudential policies; for instance, there can be situations where monetary policy would be too loose and risk creating financial imbalances, whereas macroprudential policy can be too restrictive, hampering the smooth transmission of monetary policy. Overall, while these considerations do not contradict the findings of this paper suggesting that targeted macroprudential policies are preferable to LAW, these considerations still underline the need to ensure an appropriate institutional framework with effective coordination

²⁶See “Overheating in Credit Markets: Origins, Measurement, and Policy Responses” speech by US Federal Reserve Governor Jeremy C. Stein at the “Restoring Household Financial Stability after the Great Recession: Why Household Balance Sheets Matter” research symposium sponsored by the Federal Reserve Bank of St. Louis, St. Louis, Missouri, 7 February 2013.

²⁷See also [Smets \(2014\)](#).

²⁸See [Angelini et al. \(2012b\)](#), [Goodhart et al. \(2007\)](#) and [IMF \(2015\)](#).

mechanisms among the different policy functions, with clear delineations of responsibility.

7 Conclusion

This paper analyses the cost and benefits of monetary and macroprudential policy in addressing risks to financial stability for the euro area. This question is especially relevant today given the prolonged period of very accommodative monetary policy.

In a first step we replicate the results of [Svensson \(2017\)](#) for the euro area. We find that monetary policy has cumulated net marginal costs in addressing risks to financial stability. Next we extend the framework to take into account the influence of the financial cycle. Making use of the SRI, we re-estimate the probability of a crisis start and use these estimates to determine the benefits of a given policy in reducing the probability of a crisis. Evaluating monetary policy with the extended framework, we find that the cumulated net marginal costs are lower yet still negative. Thereby, we can answer the critique of the BIS and confirm the result by Svensson regarding LAW.

In order to address the more persistent financial cycle, we argue for longer time horizons for which policy is activated and use this augmented framework to analyse macroprudential policy. We find that both a 1 pp increase in bank capital requirements and a 1 pp decrease in LTV requirements has cumulated net marginal benefits after 40 quarters. Furthermore, we assess permanent changes in macroprudential policy and find that the benefits are even greater. As a robustness check, we conduct the analysis for short-term implementation of macroprudential policies and find that these policies are less beneficial and show cumulative marginal costs in the case of an increase in bank capital requirements for four quarters.

To conclude, our analysis suggests that macroprudential policy is better suited to addressing risks to financial stability. The benefits outweigh the costs to a large degree for policy implementation with a longer time horizon.

References

- ADOLFSON, M., S. LASEEN, L. CHRISTIANO, M. TRABANDT, AND K. VALENTIN (2013): “RAMSES II-model description,” *Sveriges Riksbank Occasional Paper Series*, 12, 1009.
- ADRIAN, T. AND N. LIANG (2016): “Monetary Policy, Financial Conditions, and Financial Stability,” CEPR Discussion Papers 11394, C.E.P.R. Discussion Papers.
- ANGELINI, P., S. NERI, AND F. PANETTA (2012a): “Monetary and macroprudential rules,” Working Papers 801, Banca d’Italia.
- ANGELINI, P., S. NICOLETTI-ALTIMARI, AND I. VISCO (2012b): “Macroprudential, microprudential and monetary policies: Conflicts, complementarities and trade-offs,” Occasional Papers 140, Banca d’Italia.
- ANGELONI, I. AND E. FAIA (2013): “Capital regulation and monetary policy with fragile banks,” *Journal of Monetary Economics*, 60, 311 – 324.
- BEAN, C., M. PAUSTIAN, A. PENALVER, AND T. TAYLOR (2010): “Monetary policy after the fall,” *Proceedings - Economic Policy Symposium - Jackson Hole*, 267–328.
- BEAU, D., L. CLERC, AND B. MOJON (2012): “Macroprudential policy and the conduct of monetary policy,” Working Papers 390, Banque de France.
- BERNANKE, B. AND C. LOWN (1991): “The Credit Crunch,” *Brookings Papers on Economic Activity*, 2, 205–248.
- BERNANKE, B. S. AND M. GERTLER (1999): “Monetary policy and asset price volatility,” *Economic Review*, 17–51.
- (2001): “Should Central Banks Respond to Movements in Asset Prices?” *American Economic Review*, 91, 253–257.
- BIS (2016): “IV. Monetary Policy: more accommodation, less room,” 86th Annual Report, Bank for International Settlements.
- BORIO, C., W. ENGLISH, AND A. FILARDO (2003): “A tale of two perspectives: old or new challenges for monetary policy?” in *Monetary policy in a changing environment*, ed. by B. for International Settlements, Bank for International Settlements, vol. 19 of *BIS Papers chapters*, 1–59.
- BORIO, C. AND P. LOWE (2002): “Asset prices, financial and monetary stability: exploring the nexus,” BIS Working Papers 114, Bank for International Settlements.
- BORIO, C. E., N. KENNEDY, AND S. D. PROWSE (1994): *Exploring aggregate asset price fluctuations across countries: measurement, determinants and monetary policy implications*, 40, Bank for International Settlements, Monetary and Economic Dept.
- BRUNNERMEIER, M. K., S. ROTHER, AND I. SCHNABEL (2017): “Asset Price Bubbles and Systemic Risk,” CEPR Discussion Papers 12362, C.E.P.R. Discussion Papers.
- BRUNNERMEIER, M. K. AND Y. SANNIKOV (2013): *Reviving Money and Banking*, VoxEU.

- BRUNNERMEIER, M. K. AND I. SCHNABEL (2016): *Bubbles and Central Banks: Historical Perspectives*, Cambridge, UK: Cambridge University Press.
- CARBONI, G., M. DARRACQ PARIÈS, AND C. KOK (2013): “Exploring the nexus between macroprudential policies and monetary policy measures,” Financial stability review, special feature a, ECB.
- CECCHETTI, S. G., H. GENBERG, J. LIPSKY, AND S. WADHWANI (2000): *Asset prices and central bank policy*, Centre for Economic Policy Research.
- CECCHETTI, S. G., H. GENBERG, AND S. WADHWANI (2002): “Asset Prices in a Flexible Inflation Targeting Framework,” NBER Working Papers 8970, National Bureau of Economic Research, Inc.
- CHRISTENSEN, I., C. MEH, AND K. MORAN (2011): “Bank leverage regulation and macroeconomic dynamics,” Working Paper Series 2011-32, Bank of Canada.
- CONSTÂNCIO, V. (2018): “Financial stability risks and macroprudential policy in the euro area,” Speech at the ecb and its watchers xix conference, European Central Bank.
- DARRACQ PARIÈS, M., C. KOK, AND E. RANCOITA (2019): “Macroprudential Policy in a Monetary Union with Cross-border Banking,” Working paper, forthcoming, ECB.
- DARRACQ PARIÈS, M., C. KOK, AND D. RODRIGUEZ-PALENZUELA (2011): “Macroeconomic propagation under different regulatory regimes: Evidence from an estimated dsge model for the euro area,” *International Journal of Central Banking*, 7, 49–113.
- EUROPEAN CENTRAL BANK (2018): “Special Feature B: Predicting the likelihood and severity of financial crises over the medium term with a Cyclical Systemic Risk Indicator (CSRI),” Financial Stability Review May 2018.
- FILARDO, A. AND P. RUNGCHAROENKITKUL (2016): “A quantitative case for leaning against the wind,” BIS Working Papers 594, Bank for International Settlements.
- GELAIN, P., K. LANSING, AND J. NATVIK (2018): “Leaning Against the Credit Cycle,” *Journal of the European Economic Association*, forthcoming.
- GERDRUP, K. R., F. HANSEN, T. KROGH, AND J. MAIH (2017): “Leaning Against the Wind When Credit Bites Back,” *International Journal of Central Banking*, 13, 287–320.
- GOODHART, C., A. KASHYAP, D. TSOMOCOS, AND A. VARDOULAKIS (2007): “Financial regulation in general equilibrium,” Working Paper 17909, NBER.
- GOURIO, F., A. K. KASHYAP, AND J. SIM (2017): “The Tradeoffs in Leaning Against the Wind,” NBER Working Papers 23658, National Bureau of Economic Research, Inc.
- IMF (2015): “Monetary Policy and Financial Stability,” Staff Report, International Monetary Fund.
- JORDÀ, O., M. SCHULARICK, AND A. M. TAYLOR (2015a): “Betting the house,” *Journal of International Economics*, 96, S2 – S18, 37th Annual NBER International Seminar on Macroeconomics.

- (2015b): “Leveraged bubbles,” *Journal of Monetary Economics*, 76, 1–20.
- KOHN, D. L. (2006): “Monetary policy and asset prices: a speech at “Monetary Policy: a Journey from Theory to Practice,” a European Central Bank Colloquium held in honor of Otmar Issing, Frankfurt, Germany, March 16, 2006,” Speech 174, Board of Governors of the Federal Reserve System (U.S.).
- (2008): “Monetary policy and asset prices revisited: a speech at the Cato Institute’s 26th Annual Monetary Policy Conference, Washington, D.C., November 19, 2008,” Speech 434, Board of Governors of the Federal Reserve System (U.S.).
- KORINEK, A. AND A. SIMSEK (2016): “Liquidity Trap and Excessive Leverage,” *American Economic Review*, 106, 699–738.
- LAMBERTINI, L., C. MENDICINO, AND M. T. PUNZI (2013): “Leaning against boom-bust cycles in credit and housing prices,” *Journal of Economic Dynamics and Control*, 37, 1500 – 1522.
- LO DUCA, M., A. KOBAN, M. BASTEN, E. BENGTSSON, B. KLAUS, P. KUSMIERCZYK, J. H. LANG, C. DETKEN, T. PELTONEN, ET AL. (2017): “A new database for financial crises in European countries,” Working Paper No 194, European Central Bank.
- RÜNSTLER, G. AND M. VLEKKE (2018): “Business, housing, and credit cycles,” *Journal of Applied Econometrics*, 33, 212–226.
- SCHULARICK, M. AND A. M. TAYLOR (2012): “Credit booms gone bust: Monetary policy, leverage cycles, and financial crises, 1870-2008,” *American Economic Review*, 102, 1029–61.
- SCHÜLER, Y. S., P. HIEBERT, AND T. A. PELTONEN (2015): “Characterising the financial cycle: a multivariate and time-varying approach,” Working Paper No 1846, European Central Bank.
- SMETS, F. (2014): “Financial stability and monetary policy: How closely interlinked?” *International Journal of Central Banking*, 10, 263–300.
- SVENSSON, L. E. (2017): “Cost-benefit analysis of leaning against the wind,” *Journal of Monetary Economics*, 90, 193 – 213.
- SVERIGES RIKSBANK (2013): “Financial Imbalances in the Monetary Policy Assessment,” Monetary Policy Report July 2013, Sveriges Riksbank.
- (2014): “The effects of monetary policy on household debt,” Monetary Policy Report February 2014, Sveriges Riksbank.
- ZOU, H. AND T. HASTIE (2005): “Regularization and variable selection via the elastic net,” *Journal of the Royal Statistical Society: Series B (Statistical Methodology)*, 67, 301–320.

Tables

Table 1: Weights used in calculating SRI

	Weight
2-year change in bank credit-to-GDP ratio	0.62
3-year change in residential real estate price-to-income ratio	0.28
2-year growth rate of real total credit	0.05
2-year change in the debt-service ratio	0.05

Table 2: Start of financial crisis prediction - logit estimates

	<i>Dependent variable: $Pr(p_{i,t})$</i>			
	(1)	(2)	(3)	(4)
L0 SRI	0.450 (0.284)	-0.969*** (0.366)	-0.021 (0.561)	
L4 SRI		1.703*** (0.340)	-0.227 (0.841)	
L7 SRI				0.471 (1.808)
L8 SRI			1.414*** (0.540)	1.234 (3.005)
L9 SRI				-0.909 (3.079)
L10 SRI				0.528 (1.853)
AUROC	0.64	0.86	0.84	0.84
Observations	1,599	1,519	1,439	1,400
Log Likelihood	-83.819	-73.682	-67.228	-66.276
AIC	171.638	153.365	142.455	142.552

*Note: Standard errors are clustered at country level. Significance levels: * $p < 0.1$; ** $p < 0.05$; *** $p < 0.01$*

Figures

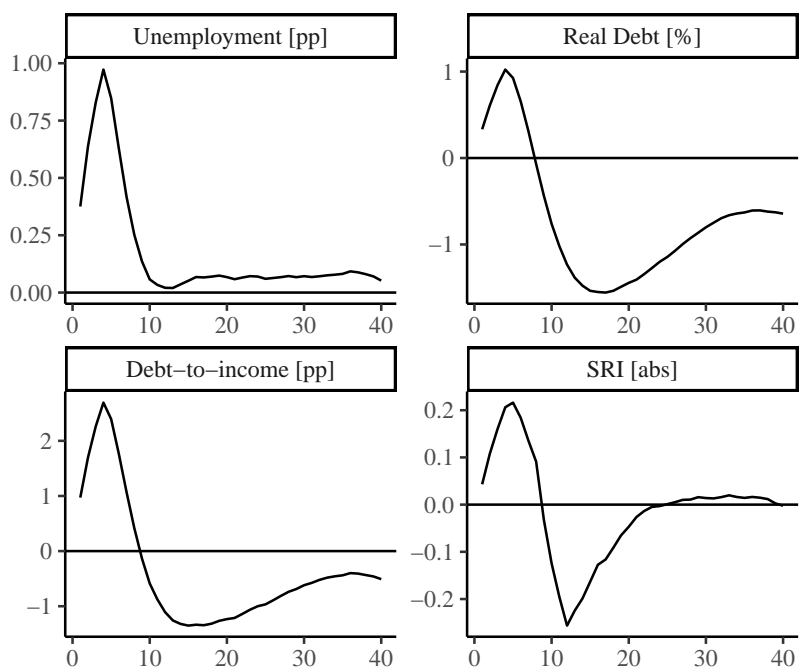

Figure 2: Deviations from steady state for a temporary monetary policy shock using the [Darracq Pariès et al. \(2011\)](#) DSGE model

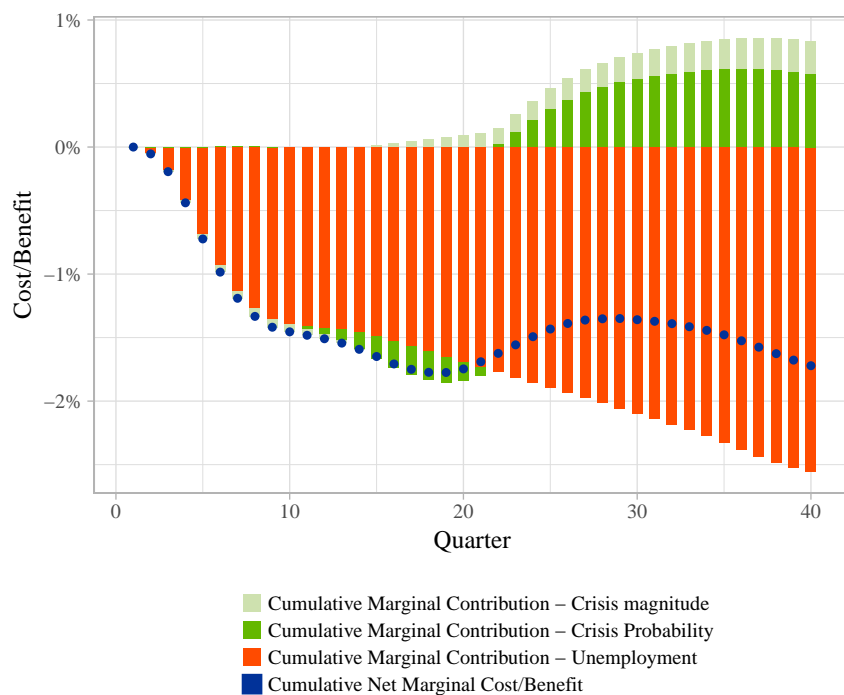

Figure 3: Cumulative Net Marginal Cost/Benefit of LAW

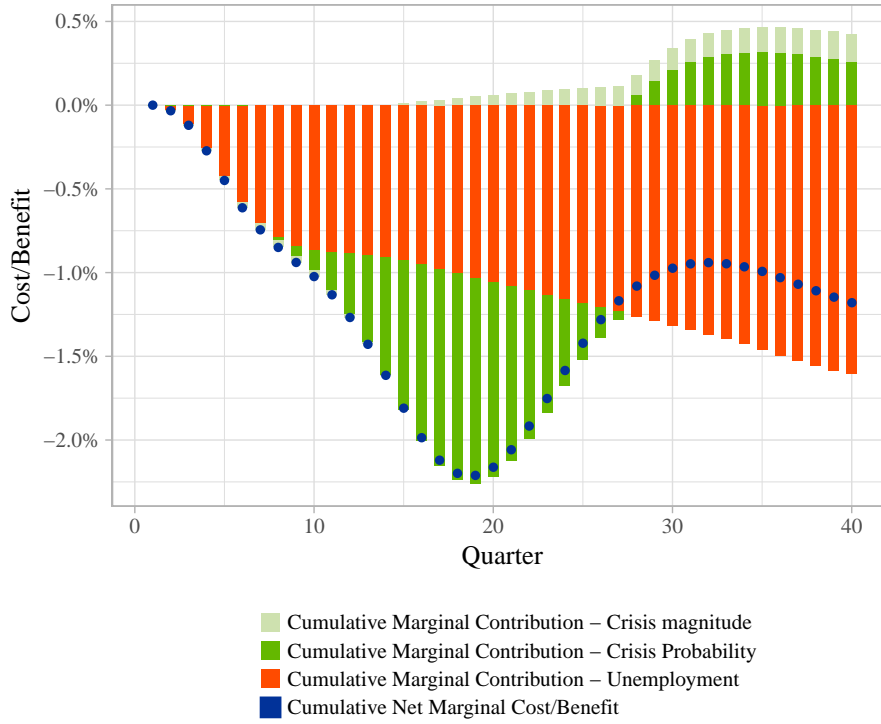

Figure 4: Cumulative Net Marginal Cost/Benefit of LAW considering the financial cycle

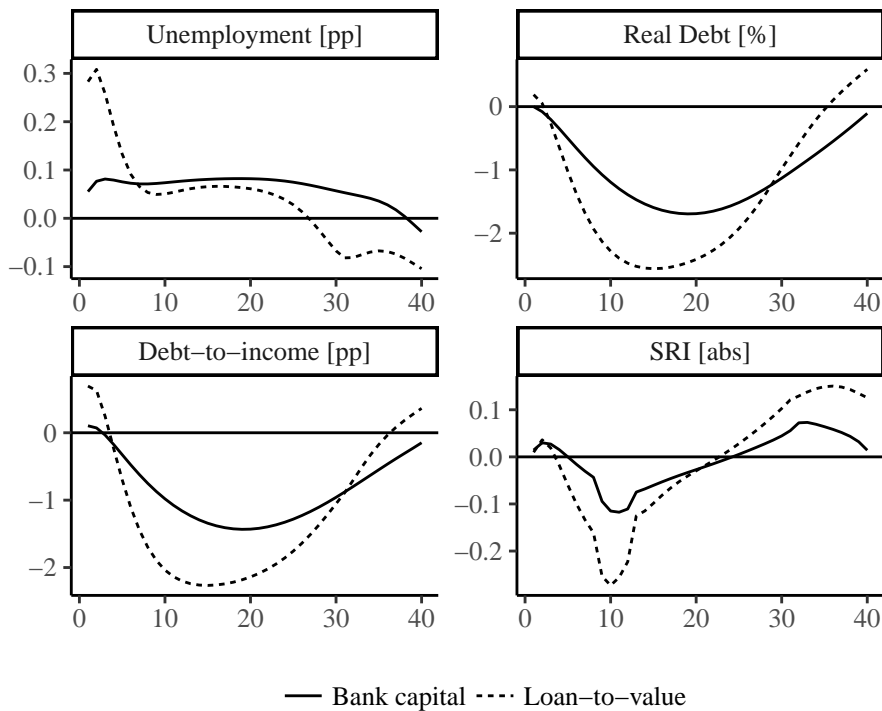

Figure 5: Deviations from steady state for a 31 quarter activation of macroprudential policy using the [Darracq Pariès et al. \(2011\)](#) DSGE model

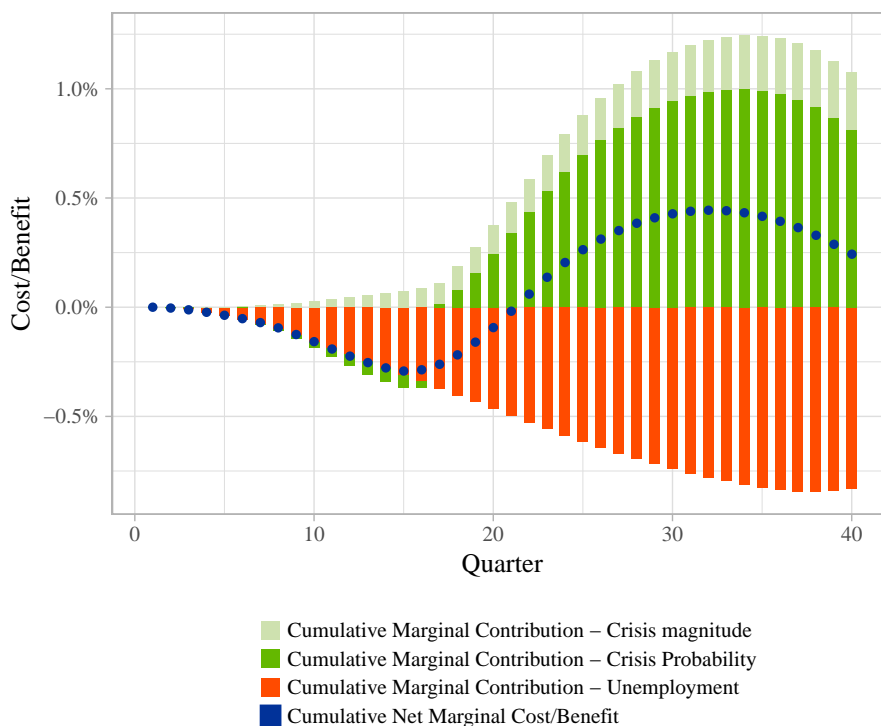

Figure 6: Cumulative Net Marginal Cost/Benefit of macroprudential policy considering the financial cycle (temporary increase of bank capital requirements - 31 quarters)

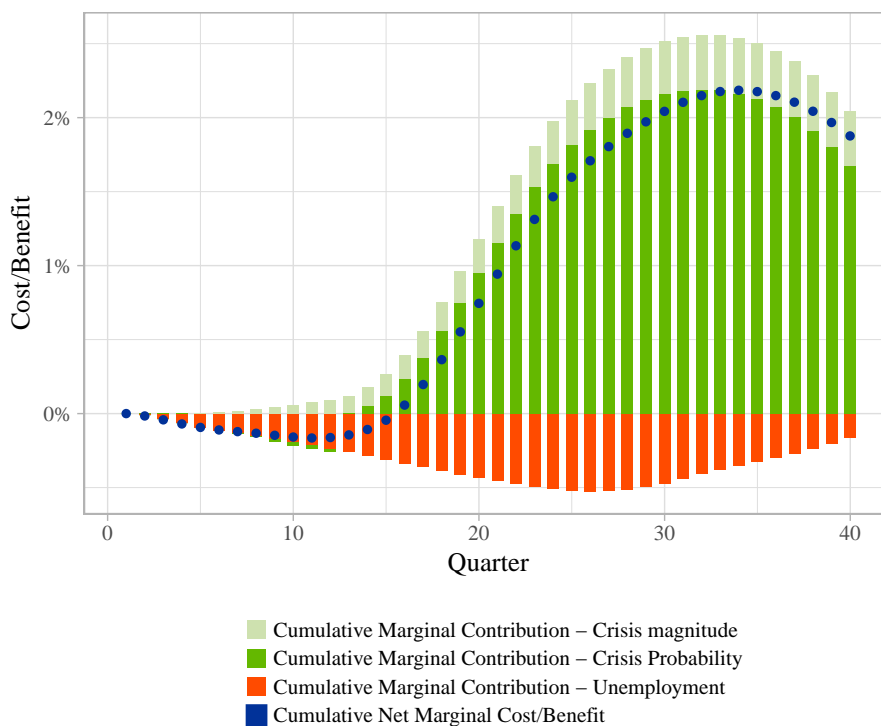

Figure 7: Cumulative Net Marginal Cost/Benefit of macroprudential policy considering the financial cycle (temporary increase of LTV requirements - 31 quarters)

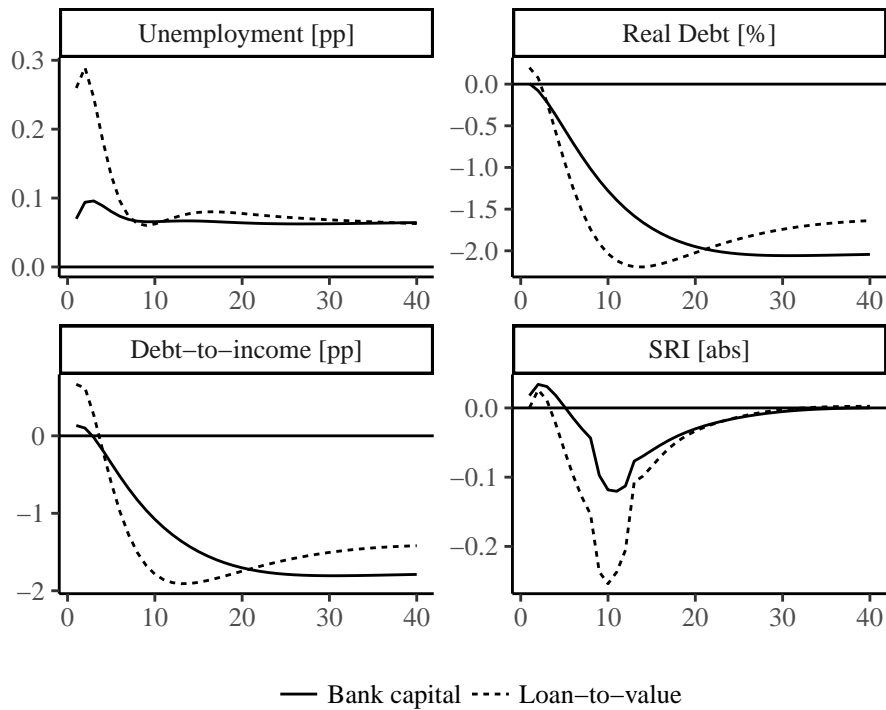

Figure 8: Deviations from steady state for permanent macroprudential policy shocks using the [Darracq Pariès et al. \(2011\)](#) DSGE model

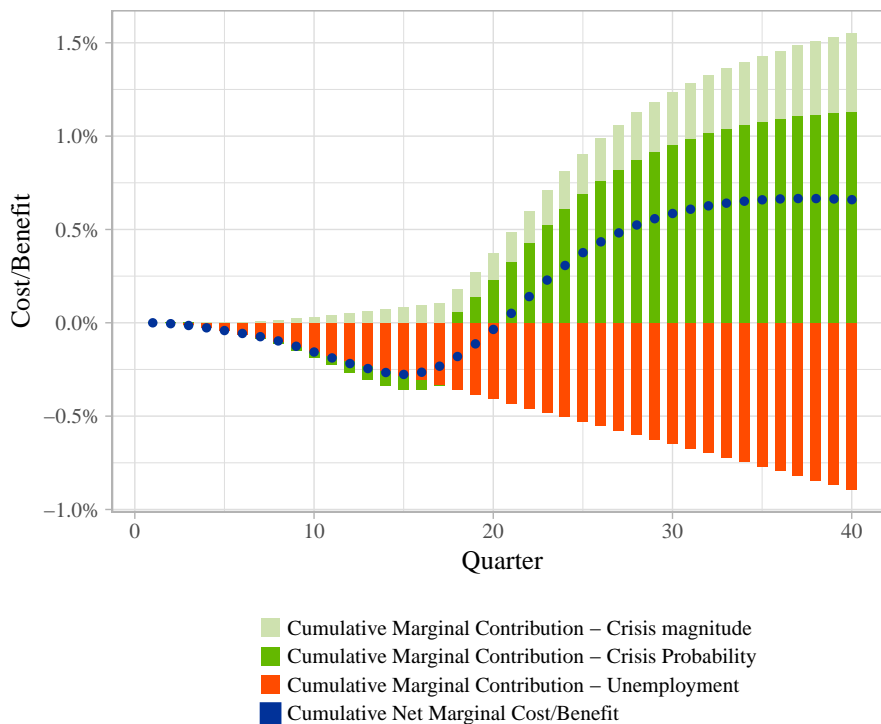

Figure 9: Cumulative Net Marginal Cost/Benefit of macroprudential policy considering the financial cycle (permanent increase of bank capital requirements)

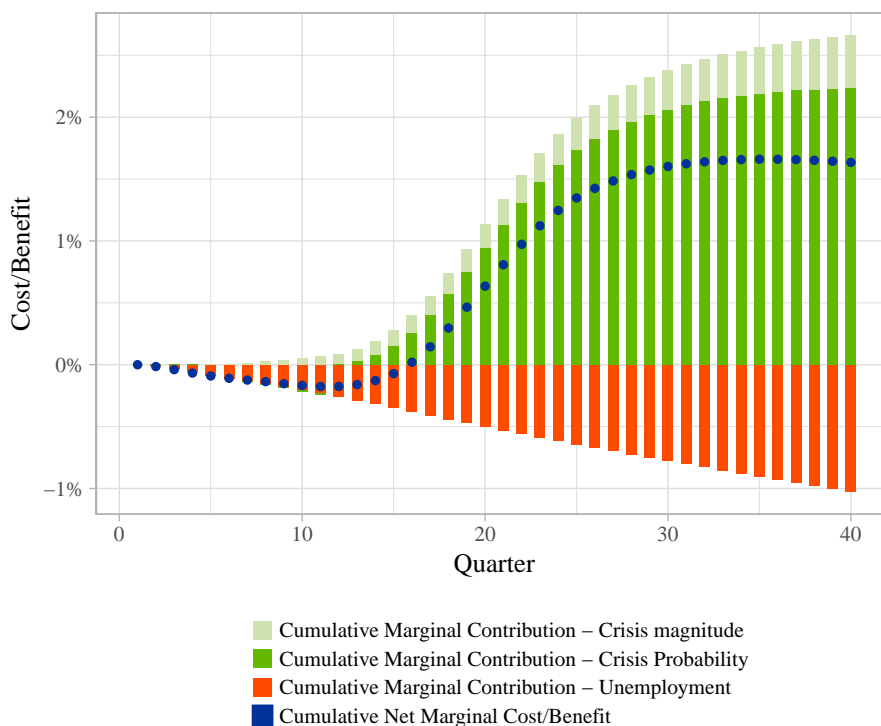

Figure 10: Cumulative Net Marginal Cost/Benefit of macroprudential policy considering the financial cycle (permanent increase of LTV requirements)

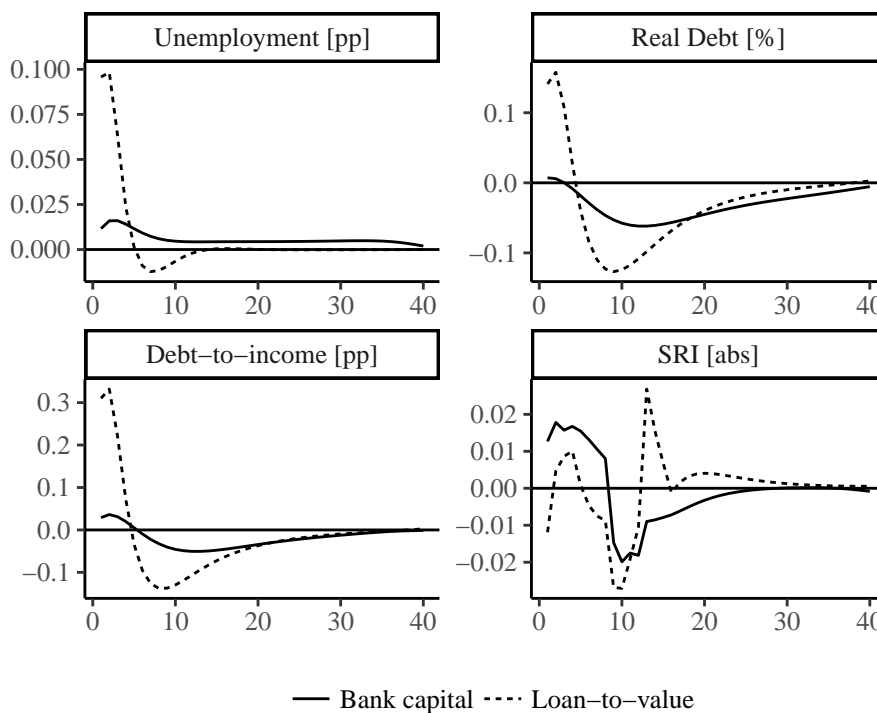

Figure 11: Deviations from steady state for a 4 quarter activation of macroprudential policy using the [Darracq Pariès et al. \(2011\)](#) DSGE model

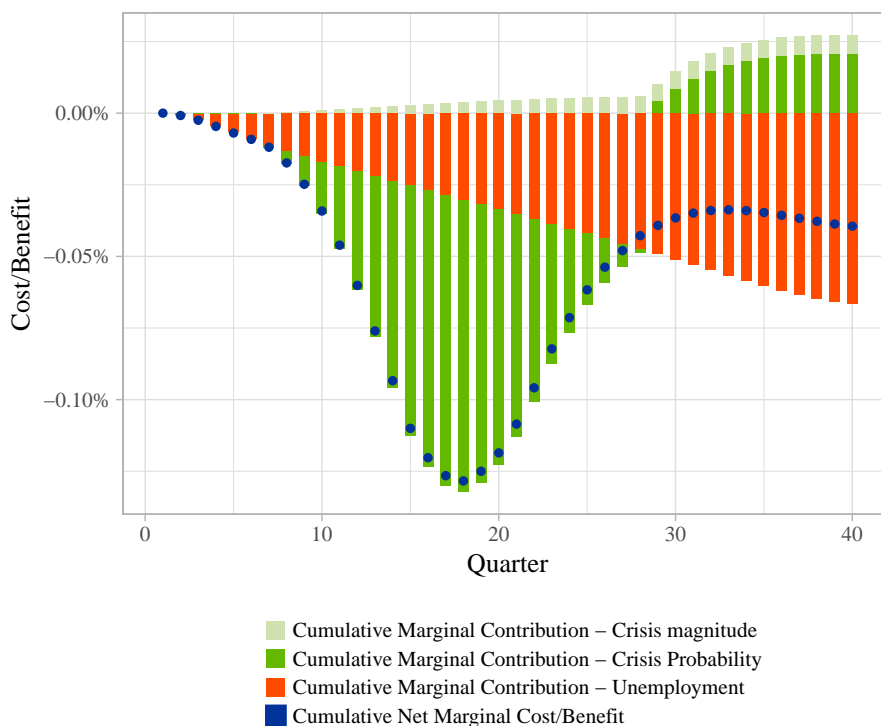

Figure 12: Cumulative Net Marginal Cost/Benefit of macroprudential policy considering the financial cycle (temporary increase of bank capital requirements - 4 quarters)

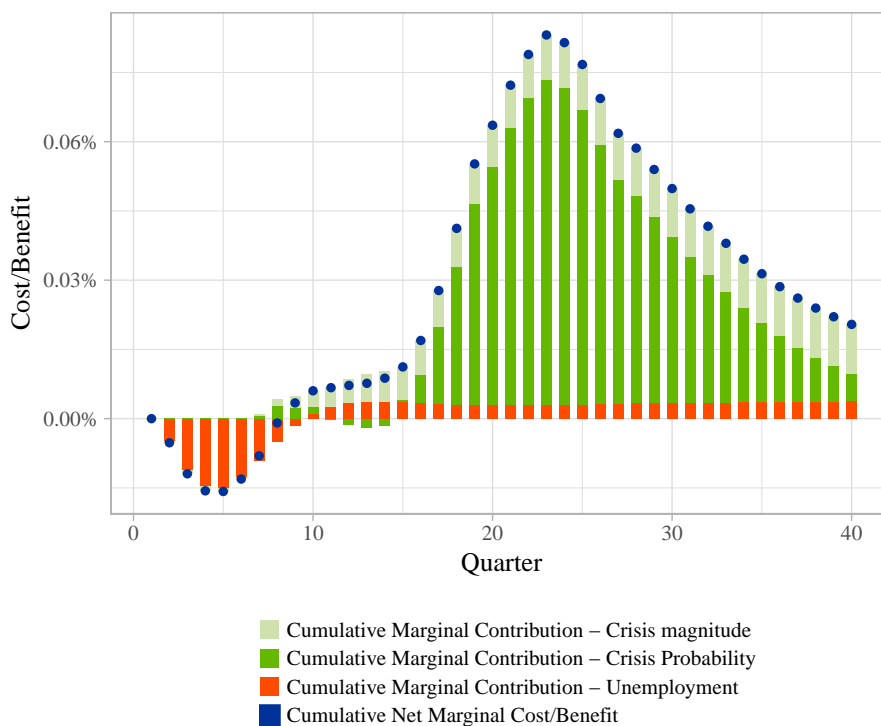

Figure 13: Cumulative Net Marginal Cost/Benefit of macroprudential policy considering the financial cycle (temporary increase of LTV requirements - 4 quarters)

Appendices

A Euro area DSGE model

The real side of the economy is modelled as a three-agent, two-sector economy, producing residential and non-residential goods. Residential goods are treated here as *durable* goods. A continuum of entrepreneurs, with unit mass, produce non-residential and residential intermediate goods under perfect competition and face financing constraints. Retailers differentiate the intermediate goods under imperfect competition and staggered price setting, while competitive distribution sectors serve final non-residential consumption as well as residential and non-residential investments. A continuum of infinitely-lived households, with unit mass, is composed of two types, differing in their relative intertemporal discount factor. A fraction $(1 - \omega)$ of households are relatively *patient*, the remaining fraction ω being *impatient*. Households receive utility from consuming both non-residential and residential goods, and disutility from labour. Impatient households are financially constrained. The labour market structure is characterised by homogeneous labour supply and monopolistically competitive unions, which gives rise to staggered wage setting.

The banking sector collects deposits from patient households and provides funds to entrepreneurs and impatient households. Three layers of frictions affect financial intermediaries. First, wholesale banking branches face capital requirements (which can be risk-insensitive or risk-sensitive) as well as adjustment costs related to their capital structure. Second, some degree of nominal stickiness generates some imperfect pass-through of market rates to bank deposit and lending rates. Finally, due to asymmetric information and monitoring cost in the presence of idiosyncratic shocks, the credit contracts proposed to entrepreneurs and impatient households factor in external financing premia which depend indirectly on the borrower's leverage. Figure 14 provides an overview of the financial contracts linking the banking sector to the real economy.

Finally, a government sector collecting taxes and providing lump-sum fiscal transfers and a monetary authority applying a standard Taylor-rule close the model.

The main differences between the DSGE model used for our euro area calculations and the model used by Svensson for Sweden are the banking sector, labour market, housing sector and

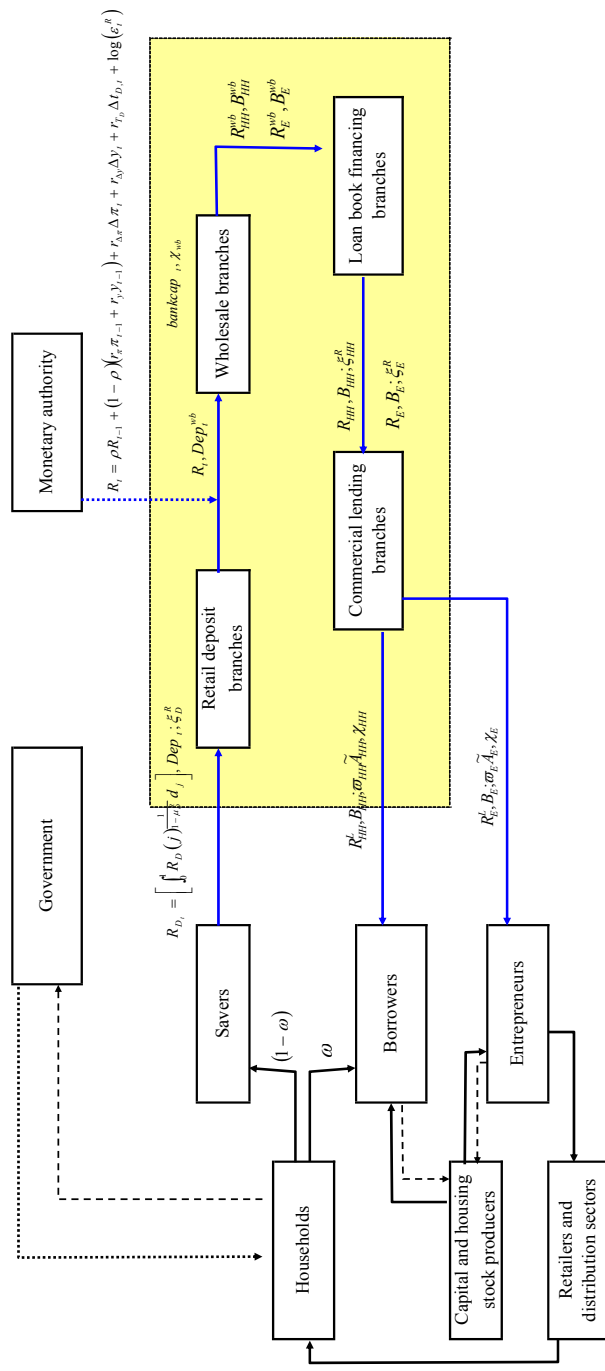

Figure 14: Structure of the Model

the open economy. [Darracq Pariès et al. \(2011\)](#) features a well-developed banking sector which intermediates deposits from patient households to firms and impatient households. Furthermore, loans to households are backed by housing. RAMSES features an open economy, has more sophisticated labour market dynamics featuring unemployment, and only incorporates risky loans between firms and households.

B Acronyms

AIC	Akaike information criterion
AUROC	Area under Receiver Operating Characteristic
BIS	Bank for International Settlements
DSGE	dynamic stochastic general equilibrium
ECB	European Central Bank
GDP	gross domestic product
GFC	Global Financial Crisis
IRF	impulse response function
LAW	“leaning against the wind”
LTV	loan-to-value
pp	percentage point
SRI	Systemic Risk Indicator

Acknowledgements

We thank Vítor Constâncio and Carmelo Salleo for valuable discussions and comments, as well as participants of presentations at Norges Bank and the CREDIT 2018 Conference. Furthermore, we thank Jan Hannes Lang for support on the Systemic Risk Indicator. Thore Kockerols gratefully acknowledges the support of the Laboratory of Excellence on Financial Regulation (Labex RéFi), and PRES heSam under the reference ANR-10-LABX-0095. The views expressed in this paper are solely the responsibility of the authors and should not be interpreted as reflecting the views of the European Central Bank. This Working Paper should not be reported as representing the views of Norges Bank. The views expressed are those of the authors and do not necessarily reflect those of Norges Bank. Any errors are our own.

Thore Kockerols

Norges Bank, Oslo, Norway; email: thore.kockerols@norges-bank.no

Christoffer Kok

European Central Bank, Frankfurt am Main, Germany; email: christoffer.kok@ecb.europa.eu

© European Central Bank, 2019

Postal address 60640 Frankfurt am Main, Germany

Telephone +49 69 1344 0

Website www.ecb.europa.eu

All rights reserved. Any reproduction, publication and reprint in the form of a different publication, whether printed or produced electronically, in whole or in part, is permitted only with the explicit written authorisation of the ECB or the authors.

This paper can be downloaded without charge from www.ecb.europa.eu, from the [Social Science Research Network electronic library](#) or from [RePEc: Research Papers in Economics](#). Information on all of the papers published in the ECB Working Paper Series can be found on the [ECB's website](#).

PDF

978-92-899-3485-5

ISSN 1725-2806

doi:10.2866/744981

QB-AR-19-004-EN-N